

Swivl™

Quick start guide

What's included?

Includes Base, Marker, Lanyard, Shims, Wall Charger, International Adapter Plugs (for international shipments only) and Audio Cable.

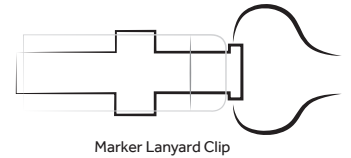
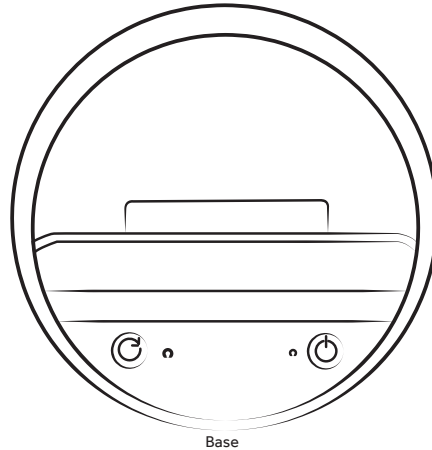

Getting Started.

The marker is stored in the integrated charging dock under the lid towards the back of the Swivl. Plug in your Swivl and charge them both at the same time. When plugged in, the LED lights indicate the following.

- Flashing Green - Base charging
- Flashing Red - Marker charging
- Solid Green - All charged

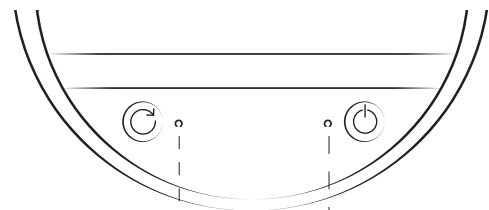
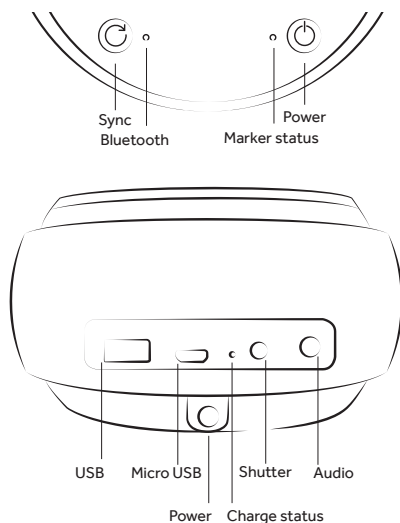
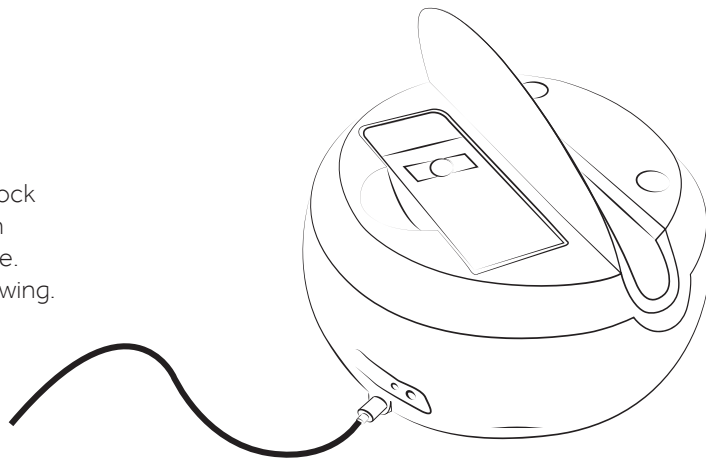

- Solid Red** - Bluetooth not connected
- Flashing Red** - Bluetooth ready to pair
- Solid Green** - Bluetooth connected
- Solid Red** - On, unconnected to Marker
- Flashing Red** - Low battery (both LEDs)
- Solid Green** - On, connected to Marker

Connecting your Device.

Power on your Swivl by holding the power button down on the base. The LED light should be green, which indicates that the base is turned on and connected to the marker.

Next, connect your device using Bluetooth.

Press and hold sync button on the Swivl Base until Bluetooth status light flashes red. Open the Bluetooth menu on your mobile device and make sure Bluetooth is turned on. Pair mobile device with Swivl. Follow prompts to complete connection and download/open Swivl Capture app.

The settings menu in the Swivl Capture app allow you to adjust the settings of the Swivl Robot.

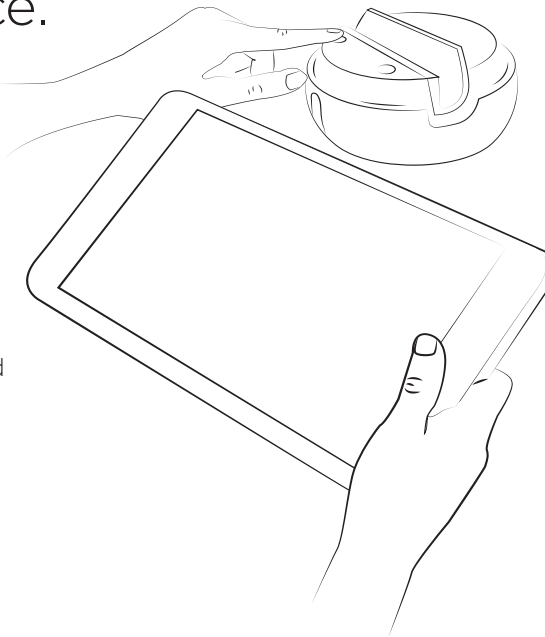

Made for

iPhone 6
iPhone 6+
iPhone 5S
iPhone 5C
iPhone 5
iPhone 4S
iPhone 4

iPad Air and iPad Air 2
iPad mini with Retina display
iPad mini
iPad (4th generation)
iPad (3rd generation)

iPod touch (5th generation)
iPod touch (4th generation)

Also works with Android mobile devices and cameras. Go to swivl.com/support for more information on compatibility.

Mounting and audio.

Mount your mobile device into the Swivl base. It is recommended that you use the **front facing camera**, so you can see the display during capture. Plug the audio cable into the base and the mobile device to receive wireless microphone feed from the marker.

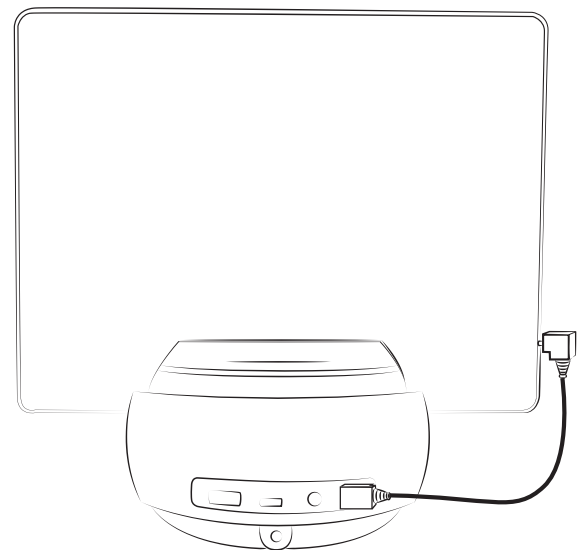

Adjusting fit.

Push removable grip holder left.
Then lift to remove.

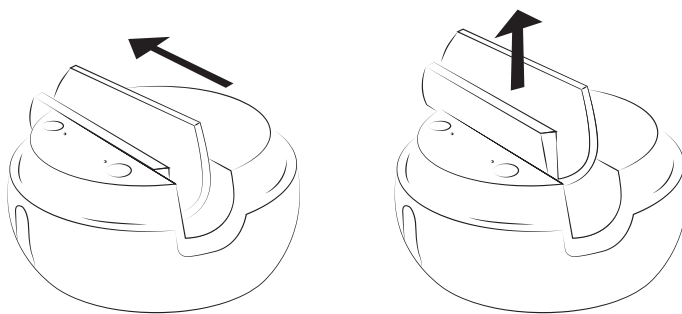

Remove shim from grip holder.

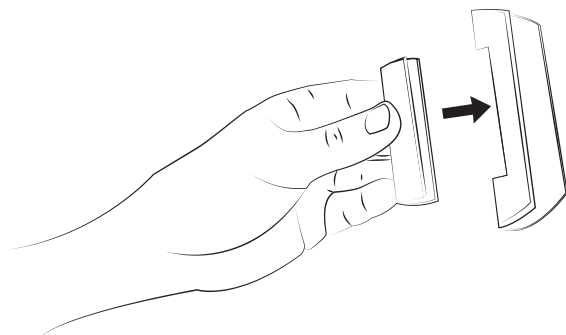

Grip fit.

Select a shim and test on edge of mobile device. Fit should be snug with no force. Return shim to grip holder and place in base. A mount anything kit is available to purchase and use with larger devices or cases.

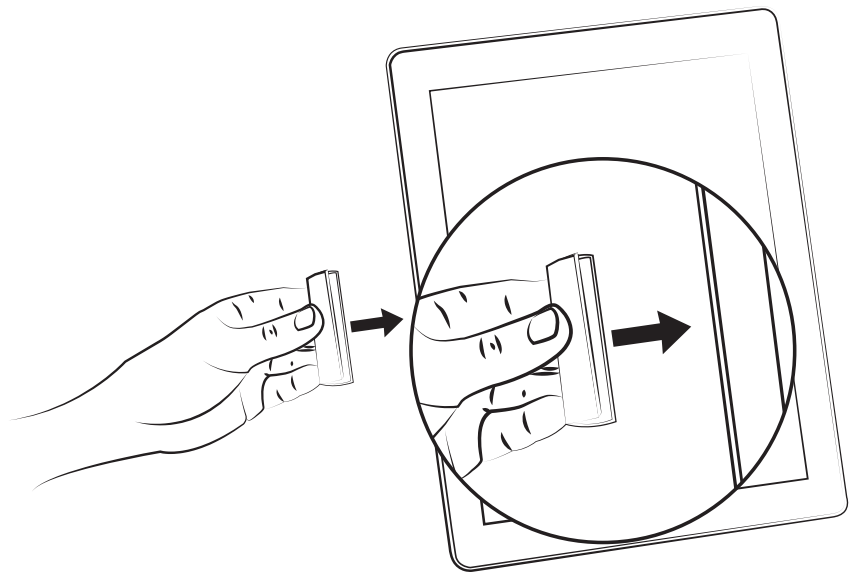
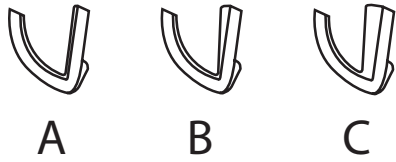

Power on.

Ensure that the power is on the base, then hold down the power button on the marker. The LED lights on the marker indicate the following

- Solid Red - On, unconnected to Base
- Flashing Red - Low battery
- Solid Green - On, Connected to Base
- Solid Red - Recording

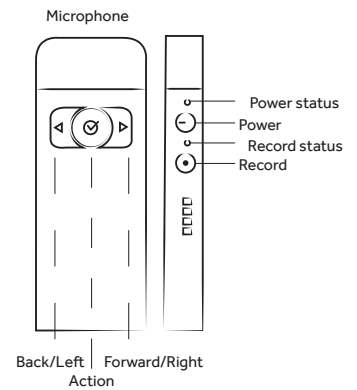
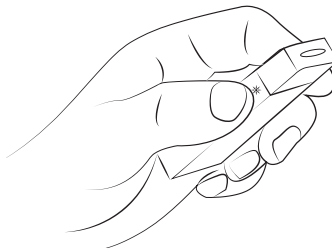

The advanced settings in the Swivl Capture app allow you to adjust the auto tilt, disable tracking, and set the checkmark action.

Horizontal motion.

Stand back 3-6 feet. Move hand from one side to another using deliberate motions.

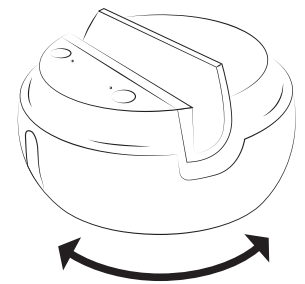
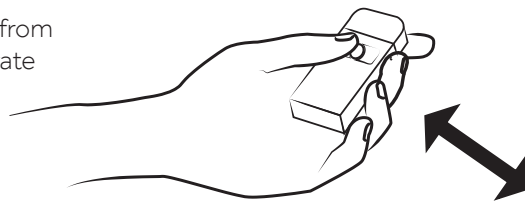

Vertical motion.

Press and hold action button on marker. Move then hold hand still. Once you have downloaded the app, you can set tilt to be "always on" in the settings menu.

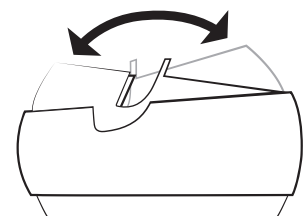
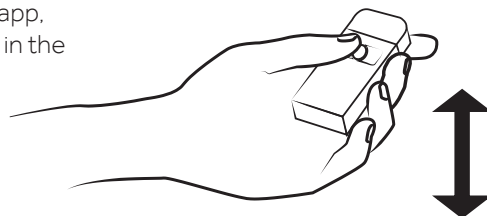

Capturing video.

While Swivl can be used with applications such as Google Hangouts, Skype, FaceTime and native camera or recording apps, the Swivl Capture App allows for easy capture and distribution of content.

Once you have opened the Swivl Capture app, follow the prompts to create a free Swivl Cloud account. Or go to **cloud.swivl.com** to create your account then enter your credentials into Swivl Capture app. Launch the app and use the record button on the marker to begin capturing video.

Managing content.

Once you have completed video capture, upload your video to Swivl Cloud. Video length and storage space are unlimited and the automatic upload feature keeps the process easy and simple. Within the cloud, users are able to upload presentations to play alongside video, making the experience more meaningful and engaging for viewers. Users are able to upload lesson plans, notes, interactive whiteboard content or PowerPoint slides to share to play alongside the video. Videos are transformed into multimedia presentations that can be embedded within an LMS, class webpage or even emailed to viewers.

Alternatively you can save videos to your Photo Library or download them directly to your computer through iTunes to use with any editing and hosting solution.

Sharing content.

Our collaboration features includes an interactive player with time stamped commenting and viewer analytics. We also provide group management features for sharing, institutional tools for managing users and much more. Our production features allow you to edit and produce video and slides for easy integration with other services.

Capturing presentations.

Presentations can be uploaded to Swivl Cloud to sync with your videos. Follow the process below and the Swivl Capture app will automatically sync to your library. Presentations can be uploaded before or after collecting video and our intelligent slide syncing will even match your slides with your video content.



Create content using any standard presentation tool, including Powerpoint, Keynote and more.



Presentations must be saved as a .pdf, .ppt, .pptx .png or .jpeg.



Navigate to cloud.swivl.com and within the library tab follow the prompts to upload presentations.

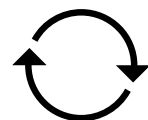

Open Swivl Capture app library to sync content. Select "Capture Video + Slides" and begin your presentation.

Positioning and room setup.

Place Swivl approximately 6-15 feet from the presenter. Use our Swivl floor or table stand for the best results. The heads-up display allows the presenter to view the live recording and uploaded presentations. See other uses on Swivl.com for ideas when using Swivl in the classroom.

The marker can be held or attached to the presenter using the lanyard or clip. Note the positioning of the marker as loose clothing may interfere with tracking.

Swivl Capture app is also designed to project your presentation to an audience while capturing video. Wirelessly project with any iOS device using an **Apple TV** or with any Android device and **Chromecast**. Use our projection kit and stand to connect your digital projector or displays.

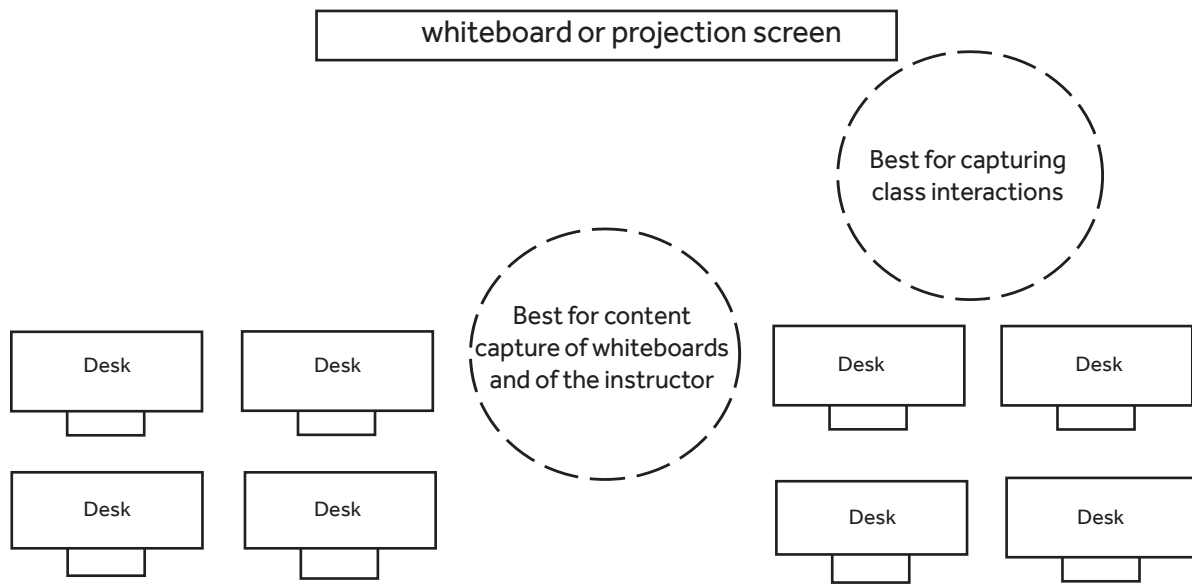

For more information visit www.swivl.com

1354 El Camino Real | San Carlos CA 94070 | (888) 837 6209 | support@swivl.com

TM and © 2015 Swivl. All rights reserved. Swivl, the Swivl logo and all other company, product and service names or slogans are trademarks of Swivl. Patent pending.

iPad, iPhone, and iPod touch are trademarks of Apple, Inc., registered in the U.S. and other countries.

Designed in California.